

Room Mate Anna Hotel,  
Barcelona, Spain







## **DOWNITO® 110**



# DOWNITO®110

- LED downlight for ambient lighting
- Smart reflector: active + passive (paintable)
- Multi-power downlight, from 16 W to 32 W
- Luminous flux range from 1200 lm to 3200 lm
- Luminaire efficiency 110 lm/W
- 2 beam angles: 40° and 70°
- Special LEDs to improve the food and retail colors
- IP20, IP40 and IP54
- Accessories available: diffuser clear y opal

- Downlight LED para iluminación ambiental
- Reflector Smart: activo + pasivo (pintable)
- Downlight Multi-power, de 16 W a 32 W
- Flujos lumínicos de 1200 lm a 3200 lm
- Eficiencia de la luminaria 110 lm/W
- 2 ángulos de apertura: 40° y 70°
- IP20, IP40 y IP54
- LEDs especiales para potenciar los colores en alimentación y retail
- Accesorios disponibles: difusor transparente y opal

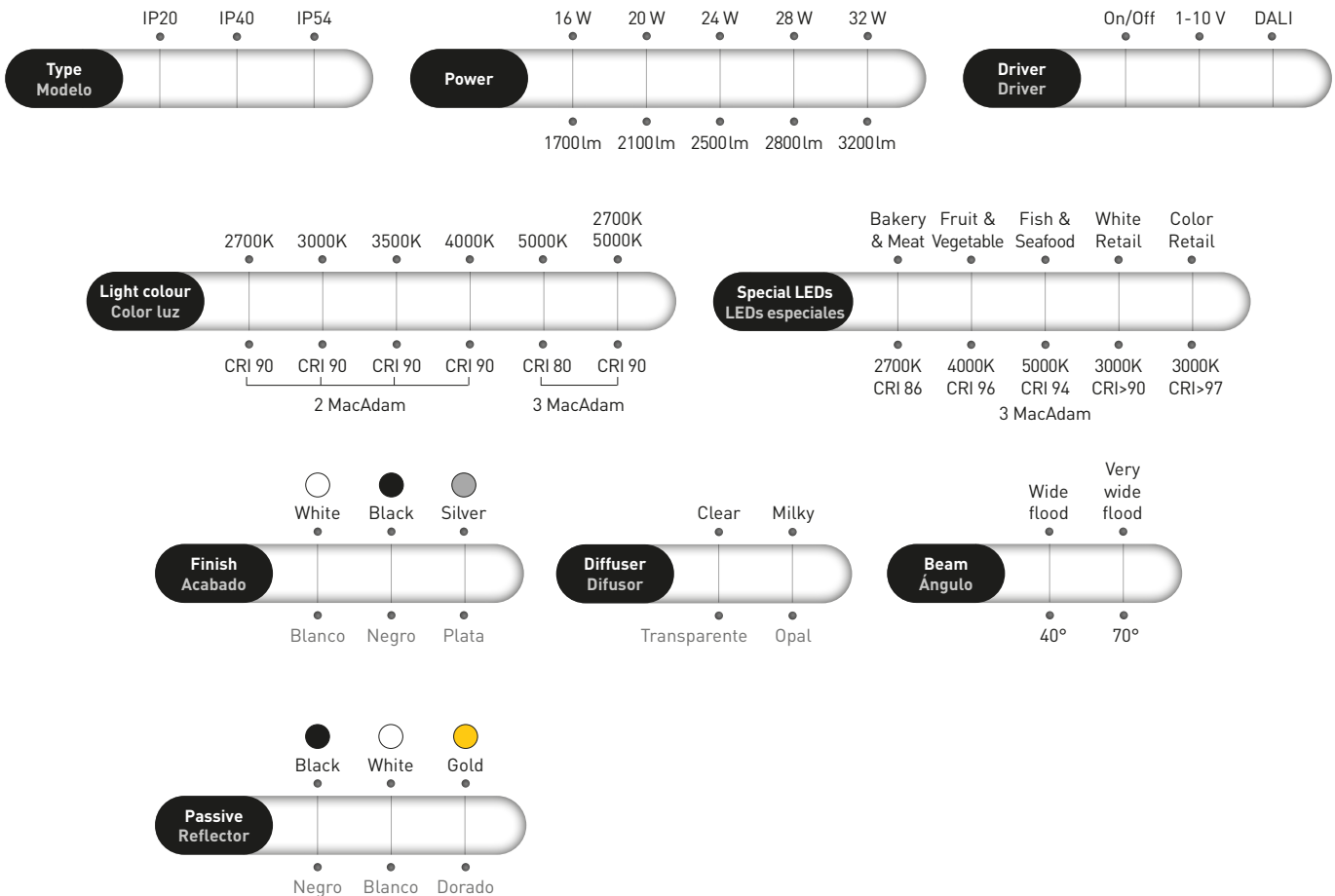

The standard IP20 version is delivered with chromed reflector. Driver not included.  
La versión estándar IP20 se suministra con reflector cromado. Driver no incluido.

The standard IP40 an IP54 versions are delivered with clear diffuser and chromed reflector. Driver not included.  
Las versiones estándar IP40 y P54 se suministran con difusor transparente y reflector cromado. Driver no incluido.

**SPECIFICATIONS  
CARACTERÍSTICAS**

UGR <19	IP20 IP40 IP54		on/off	DALI	1-10V	Driver Not Included	AL Housing	Ta min -20°C -4°F Ta max +50°C max +122°F	
------------	----------------------	--	--------	------	-------	---------------------------	---------------	--	--

Downito® 110						
Measures	Ø110 x 100 mm					
Weight	0,8 kg					
16 W (500 mA)						
Color temperatures	<b>2700K – CRI 90</b>	<b>3000K – CRI 90</b>	<b>3500K – CRI 90</b>	<b>4000K – CRI 90</b>	<b>5000K – CRI 80</b>	<b>2700K-5000K – CRI 90</b>
Lumens output	40° - 1270 lm 70° - 1175 lm	40° - 1310 lm 70° - 1215 lm	40° - 1368 lm 70° - 1269 lm	40° - 1425 lm 70° - 1320 lm	40° - 1760 lm 70° - 1625 lm	40° - 1143-1315 lm 70° - 1058-1216 lm
Luminaire efficiency	73 to 79 lm/W	76 to 82 lm/W	79 to 85 lm/W	82 to 89 lm/W	102 to 110 lm/W	66 to 84 lm/W
20 W (600 mA)						
Color temperatures	<b>2700K – CRI 90</b>	<b>3000K – CRI 90</b>	<b>3500K – CRI 90</b>	<b>4000K – CRI 90</b>	<b>5000K – CRI 80</b>	<b>2700K-5000K – CRI 90</b>
Lumens output	40° - 1520 lm 70° - 1405 lm	40° - 1575 lm 70° - 1460 lm	40° - 1643 lm 70° - 1520 lm	40° - 1710 lm 70° - 1580 lm	40° - 2106 lm 70° - 1948 lm	40° - 1368-1573 lm 70° - 1265-1454 lm
Luminaire efficiency	70 to 76 lm/W	73 to 79 lm/W	76 to 82 lm/W	79 to 86 lm/W	98 to 105 lm/W	63 to 79 lm/W
24 W (700 mA)						
Color temperatures	<b>2700K – CRI 90</b>	<b>3000K – CRI 90</b>	<b>3500K – CRI 90</b>	<b>4000K – CRI 90</b>	<b>5000K – CRI 80</b>	<b>2700K-5000K – CRI 90</b>
Lumens output	40° - 1775 lm 70° - 1645 lm	40° - 1835 lm 70° - 1700 lm	40° - 1915 lm 70° - 1773 lm	40° - 1995 lm 70° - 1845 lm	40° - 2460 lm 70° - 2275 lm	40° - 1598-1837 lm 70° - 1480-1703 lm
Luminaire efficiency	68 to 74 lm/W	70 to 76 lm/W	74 to 80 lm/W	73 to 83 lm/W	95 to 103 lm/W	62 to 77 lm/W
28 W (800 mA)						
Color temperatures	<b>2700K – CRI 90</b>	<b>3000K – CRI 90</b>	<b>3500K – CRI 90</b>	<b>4000K – CRI 90</b>	<b>5000K – CRI 80</b>	<b>2700K-5000K – CRI 90</b>
Lumens output	40° - 2026 lm 70° - 1895 lm	40° - 2095 lm 70° - 1942 lm	40° - 2185 lm 70° - 2024 lm	40° - 2275 lm 70° - 2106 lm	40° - 2810 lm 70° - 2600 lm	40° - 1824-2098 lm 70° - 1705-1962 lm
Luminaire efficiency	68 to 72 lm/W	70 to 75 lm/W	72 to 78 lm/W	75 to 81 lm/W	93 to 100 lm/W	61 to 75 lm/W
32 W (900 mA)						
Color temperatures	<b>2700K – CRI 90</b>	<b>3000K – CRI 90</b>	<b>3500K – CRI 90</b>	<b>4000K – CRI 90</b>	<b>5000K – CRI 80</b>	<b>2700K-5000K – CRI 90</b>
Lumens output	40° - 2280 lm 70° - 2110 lm	40° - 2360 lm 70° - 2185 lm	40° - 2455 lm 70° - 2277 lm	40° - 2560 lm 70° - 2370 lm	40° - 3160 lm 70° - 2923 lm	40° - 2052-2340 lm 70° - 1899-2165 lm
Luminaire efficiency	66 to 71 lm/W	68 to 74 lm/W	71 to 77 lm/W	74 to 80 lm/W	91 to 99 lm/W	59 to 73 lm/W

Downito® 110 Special LEDs					
Measures	Ø110 x 100 mm				
Weight	0,8 kg				
24 W (700 mA)					
Color temperatures	<b>Bakery &amp; Meat 2700K – CRI 86</b>	<b>Fruit &amp; Vegetable 4000K – CRI 96</b>	<b>Fish &amp; Seafood 5000K – CRI 94</b>	<b>White Retail 3000K – CRI &gt; 90</b>	<b>Color Retail 3000K – CRI &gt; 97</b>
Lumens output	40° - 1331 lm 70° - 1234 lm	40° - 1552 lm 70° - 1438 lm	40° - 1604 lm 70° - 1513 lm	40° - 1743 lm 70° - 1615 lm	40° - 1652 lm 70° - 1530 lm
Luminaire efficiency	51 to 55 lm/W	60 to 65 lm/W	63 to 67 lm/W	67 to 73 lm/W	64 to 69 lm/W
32 W (900 mA)					
Color temperatures	<b>Bakery &amp; Meat 2700K – CRI 86</b>	<b>Fruit &amp; Vegetable 4000K – CRI 96</b>	<b>Fish &amp; Seafood 5000K – CRI 94</b>	<b>White Retail 3000K – CRI &gt; 90</b>	<b>Color Retail 3000K – CRI &gt; 97</b>
Lumens output	40° - 1710 lm 70° - 1583 lm	40° - 1997 lm 70° - 1848 lm	40° - 2063 lm 70° - 1910 lm	40° - 2242 lm 70° - 2076 lm	40° - 2124 lm 70° - 1966 lm
Luminaire efficiency	49 to 53 lm/W	58 to 63 lm/W	60 to 64 lm/W	65 to 70 lm/W	61 to 66 lm/W



“Great Amber” Concert Hall,  
Liepaja, Latvia

Color temperature conform to ANSI C78.377A.  
Lumens measurement conform to LM-79-08.  
Lumens maintenance conform to LM-80-08.

Temperatura de color según normativa ANSI C78.377A.  
Medición lumens según normativa LM-79-08.  
Mantenimiento lumens según normativa LM-80-08.



## MEASURES MEDIDAS

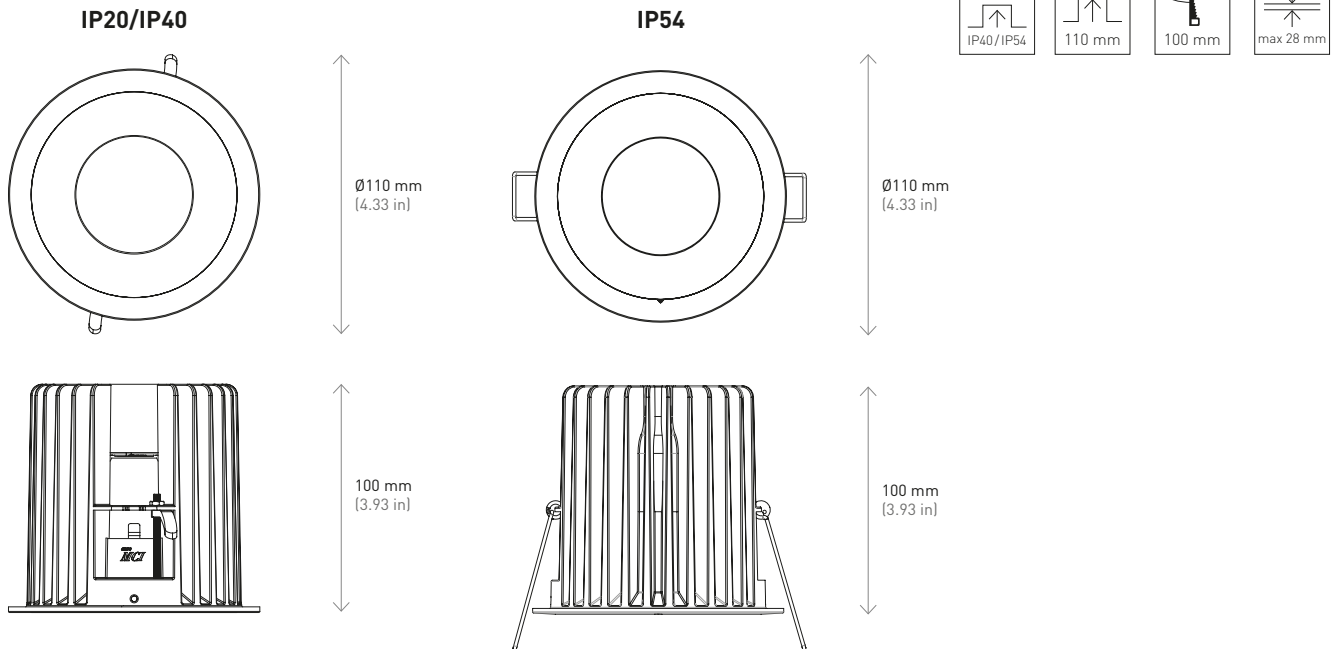

## FINISHES ACABADOS

In order to satisfy all our customers, three different finishes are available: white, silver and black.  
Con el fin de satisfacer las necesidades de nuestros clientes, está disponible en tres acabados: blanco, plata y negro.



White.  
Blanco.

(RAL 9003)



Silver.  
Plata.

(RAL 9006)



Black.  
Negro.

(RAL 9011)

## DETAILS DETALLES

Different finishes for the passive reflector are available: white, black and gold.  
Se pueden escoger diferentes acabados para el reflector pasivo: blanco, negro y dorado.



DETAILS  
DETALLES

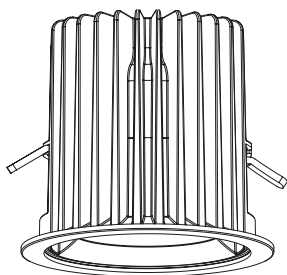

COB



COB holder

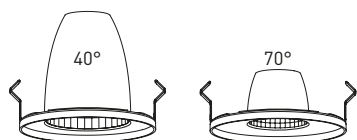

Active reflector  
(Engineering by Bartenbach)



Diffuser (IP40)  
Clear and Milky



Gasket (IP54)

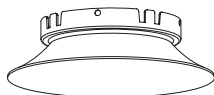

Passive reflector (paintable)



MCI TECHNOLOGY

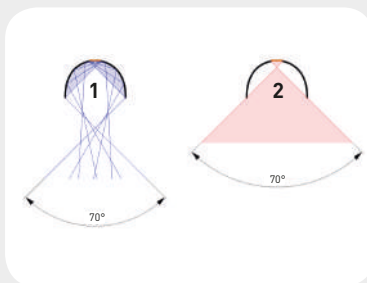
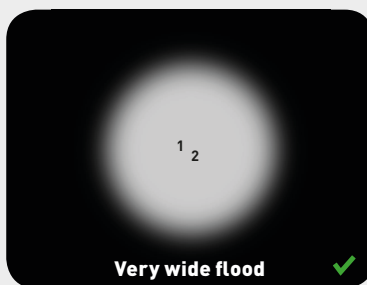
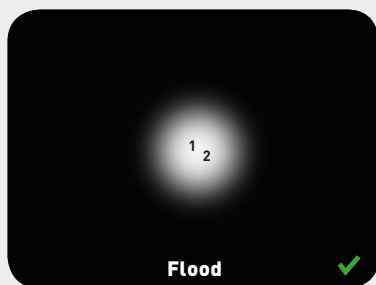

Reflected light (1) + Direct light (2) = **MATCH**

**CONCLUSION:**

There is no residual light and maximum efficiency.

Luz reflejada (1) + Luz directa (2) = **COINCIDEN**

**CONCLUSIÓN:**

No hay luz residual y máxima eficiencia.

OTHER TECHNOLOGIES



Halo shapes and low efficiency  
Halos y baja eficiencia

# DOWNITO® 110

## LIGHT DISTRIBUTION CURVES FOTOMETRÍAS

### Downito® 110

3500K 40°

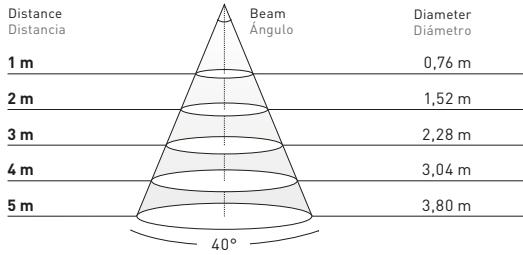

	16 W	24 W	32 W
1 m	1.418 lux	1.984 lux	2.551 lux
2 m	355 lux	496 lux	638 lux
3 m	158 lux	220 lux	283 lux
4 m	89 lux	124 lux	159 lux
5 m	57 lux	79 lux	102 lux

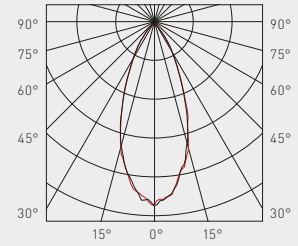

### Downito® 110

3500K 70°

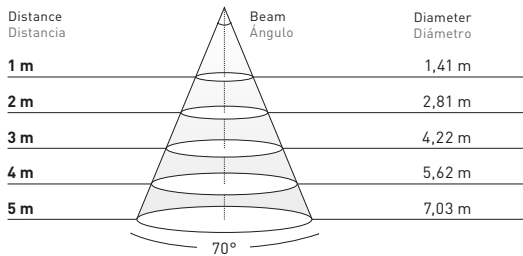

	16 W	24 W	32 W
1 m	600 lux	840 lux	1.079 lux
2 m	150 lux	210 lux	270 lux
3 m	67 lux	93 lux	120 lux
4 m	38 lux	53 lux	67 lux
5 m	24 lux	34 lux	43 lux

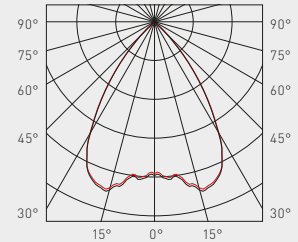

Data calculated with **Downito® 110 (3500K)**.  
Lumen measurement complies with **UNE-EN 13032 / IES LM-79-08** testing procedures.  
Light distribution curves are available at [www.mclight.com](http://www.mclight.com).  
Due to continuous improvements and innovations, specifications may change without notice.

Datos calculados con **Downito® 110 (3500K)**.  
Ensayado bajo las especificaciones de la norma **UNE-EN 13032 / IES LM-79-08**.  
Fotometrías disponibles en [www.mclight.com](http://www.mclight.com).  
Debido a las continuas mejoras e innovaciones, las especificaciones pueden cambiar sin previo aviso.

## CONNECTIONS CONEXIONES

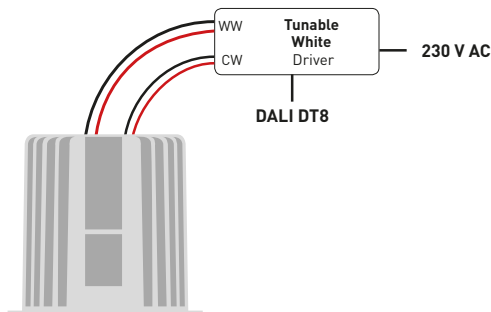
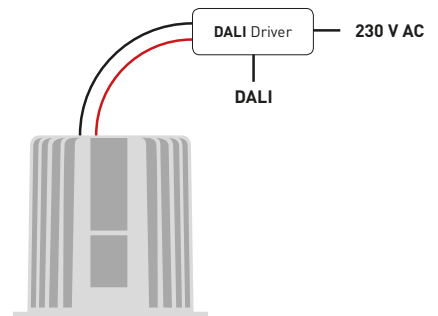
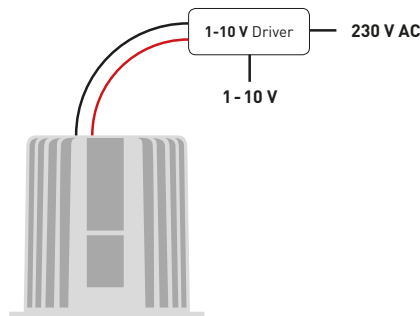
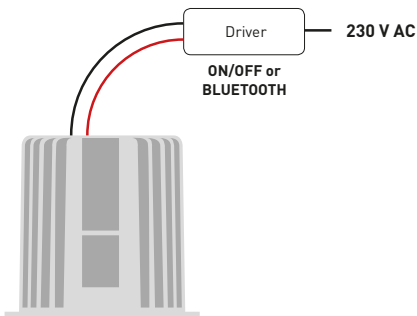

REFERENCES  
REFERENCIAS

7112 X X X /XX/XX

COLOR COLOR

- /90/2K7 2700K
- /90/3K 3000K
- /90/3K5 3500K
- /90/4K 4000K
- /80/5K 5000K
- /2K7-5K Tunable white
- /86/2K7 Bakery & Meat
- /96/4K Fruit & Vegetable
- /94/5K Fish & Seafood
- /90/3KX White Retail
- /97/3K Color Retail

BEAM ÁNGULO

- 1 40°
- 2 70°

FINISHES ACABADOS

- 0 Silver Plata
- 2 Black Negro
- 3 White Blanco

TYPE MODELO

- 0 IP20
- 1 IP40
- 2 IP54

OPTIONS  
OPCIONES

The standard version is delivered with:  
clear diffuser and chrome reflector.

La versión estándar se suministra con:  
difusor transparente y reflector pasivo cromado.

DIFFUSER DIFUSOR (IP40/IP54)

- Clear Transparente (Standard)
- Milky Opal

PASSIVE REFLECTOR REFLECTOR PASIVO

- Chrome Cromado (Standard)
- Black Negro
- White Blanco
- Gold Dorado

DRIVERS REFERENCES  
REFERENCIAS DRIVERS



Drivers 500mA			
3090773	On-Off Led Driver 500mA 16W	Led Driver 500mA 16W On-Off	
3090774	1-10V Led Driver 500mA 18W	Led Driver 500mA 18W 1-10V	1
Drivers 700mA			
3091009	On-Off Led Driver 700mA 3.5W-30W	Led Driver 700mA 3.5W-30W On-Off	
3090777	1-10V Led Driver 700mA 24W	Led Driver 700mA 24W 1-10V	
Drivers 900mA			
3090779	On-Off Led Driver 900mA 32W	Led Driver 900mA 32W On-Off	2
3090780	1-10V Led Driver 900mA 32W	Led Driver 900mA 32W 1-10V	
Drivers multi-power			
3091012	On-Off Led Driver Multi-power 300mA-1050mA 13W-40W	Led Driver Multi-power 300mA-1050mA 13W-40W On-Off	
3090704	DALI / 1-10V / PUSH Led Driver Multi-power Max.50W	Led Driver Multi-power Max.50W DALI / 1-10V / PUSH	3
Drivers multi-power Bluetooth			
7150930	Casambi Led Driver Multi-power 300mA-1050mA 38W	Led Driver Multi-power 300mA-1050mA 38W Casambi	4
7150931	Zigbee Led Driver Multi-power 300mA-1050mA 38W	Led Driver Multi-power 300mA-1050mA 38W Zigbee	5
Driver tunable white			
3091017	DALI DT8 Led Driver 900mA 45W Tunable White	Led Driver 900mA 45W Tunable White DALI DT8	6

MULTI-POWER DRIVER CONNECTIONS TABLE  
TABLA DE CONEXIONES DRIVER MULTI-POWER

		500 mA	550 mA	600 mA	650 mA	700 mA	750 mA	800 mA	850 mA	900 mA
3091012	On/off	16 W	18 W	20 W	22 W	24 W	26 W	28 W	30 W	32 W
3090704	1-10 V / DALI	16 W	18 W	-	22 W	24 W	26 W	-	30 W	32 W

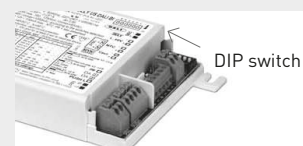

To control the luminaires via Bluetooth see page 312  
Para controlar las luminarias via Bluetooth consultar página 312